

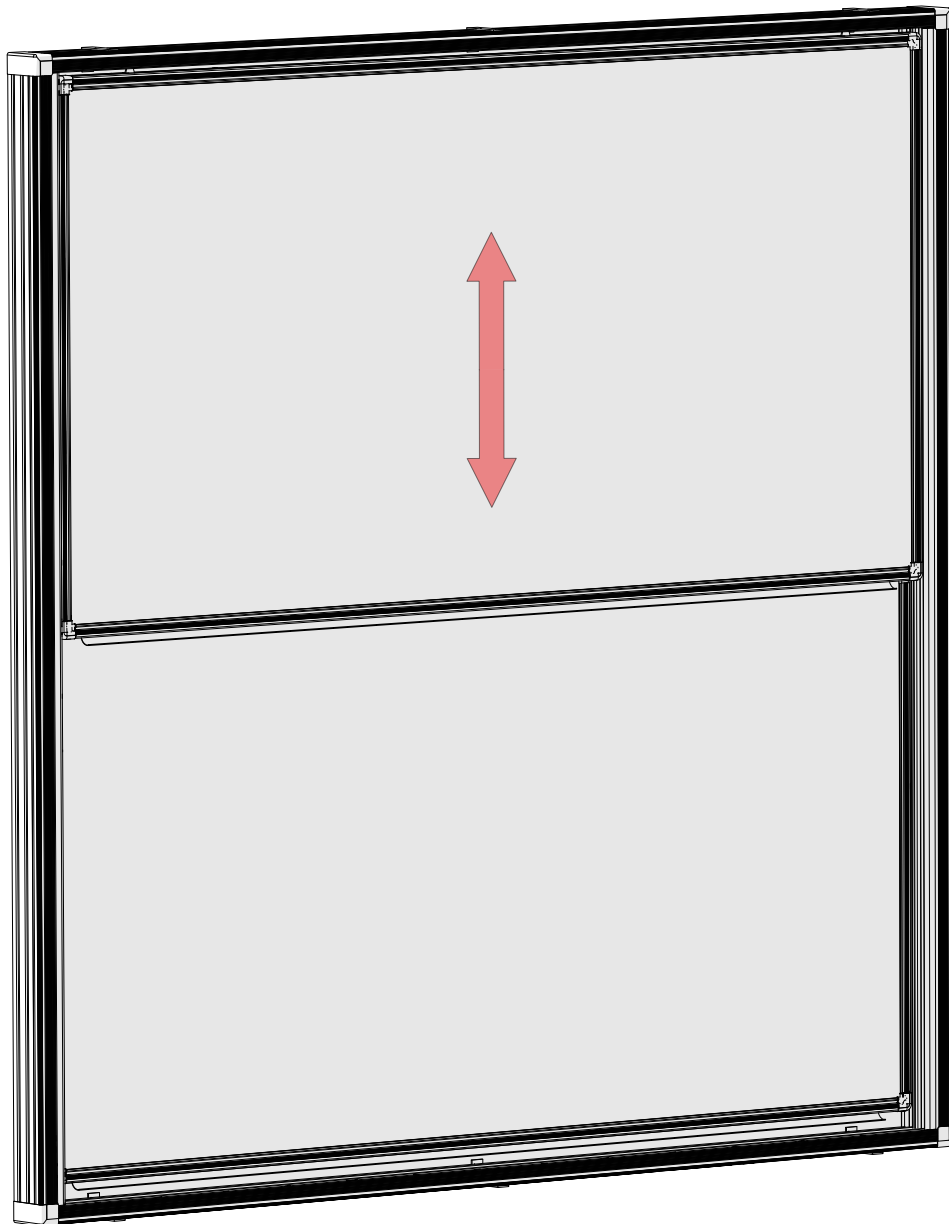

LEARNING
SURFACES

Horizontal Slider

Assembly & Installation



Step 1

Connect Both side rails to the bottom rail. Gear side should face away from Bottom rail.

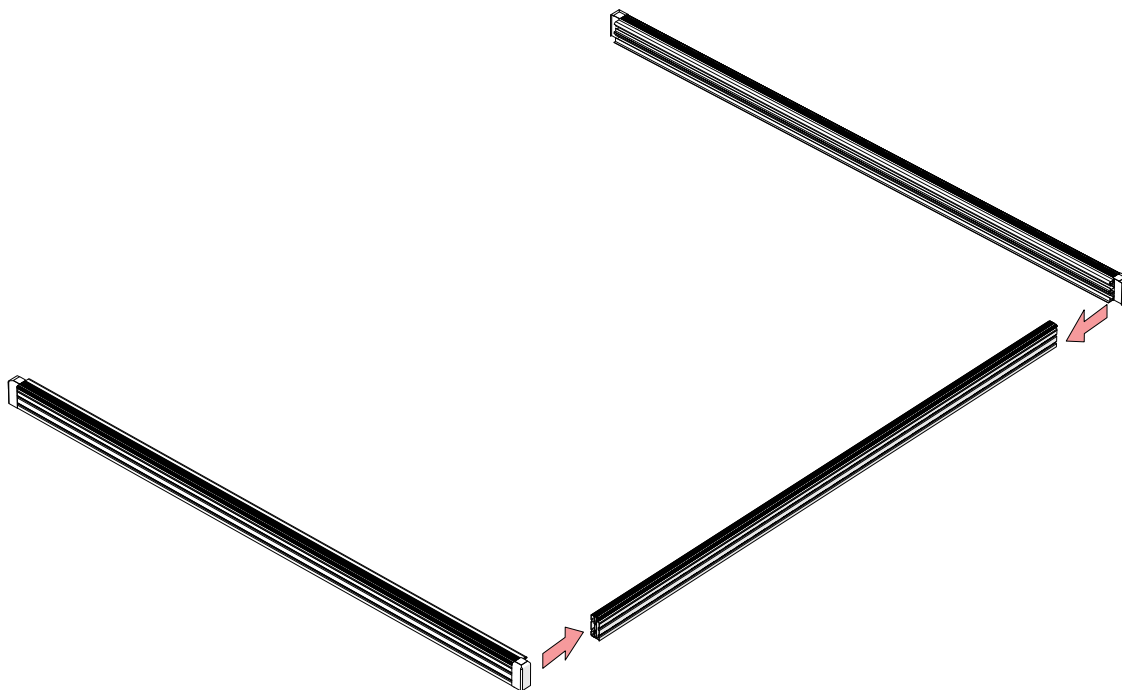

Step 2

Guide both sliders through the channels. Keep in mind the chains will be getting hooked onto gear in the side rails.

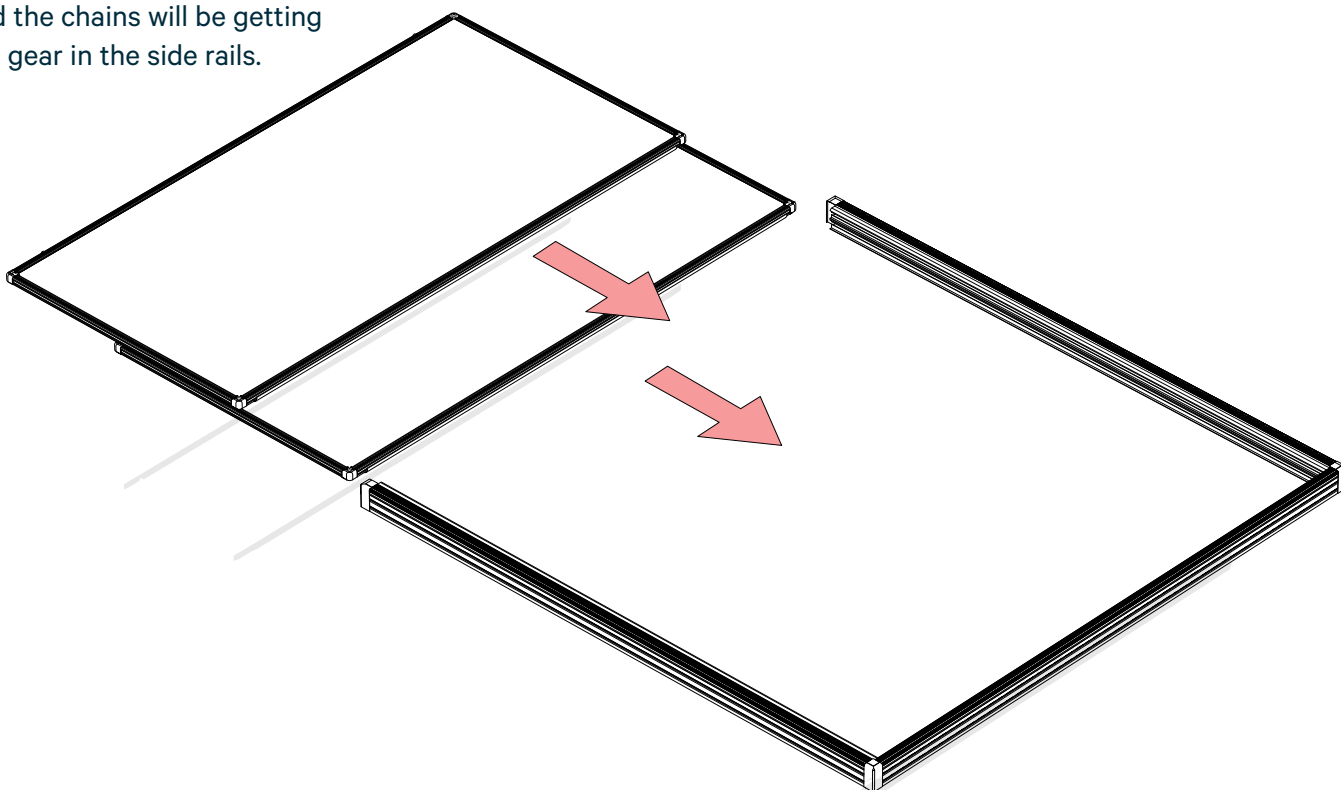

Step 3

Loop the chain around the gears at the top.

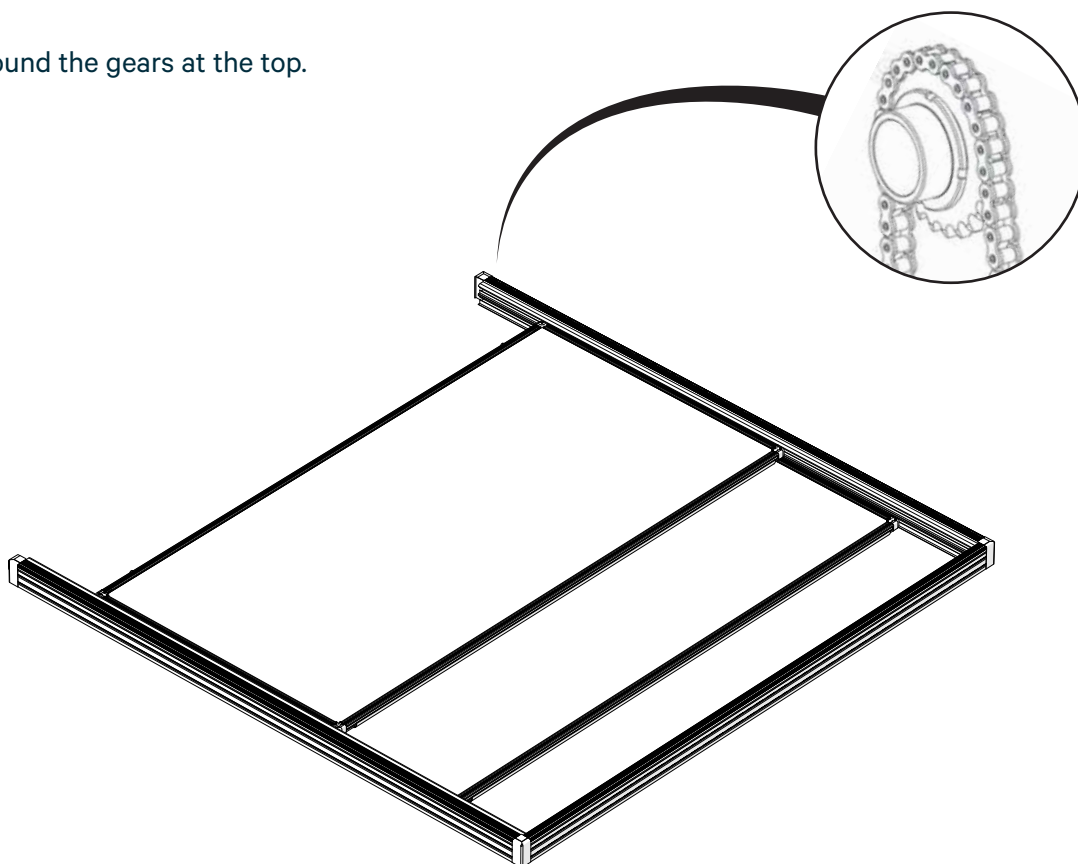

Step 4

Connect the top rail.

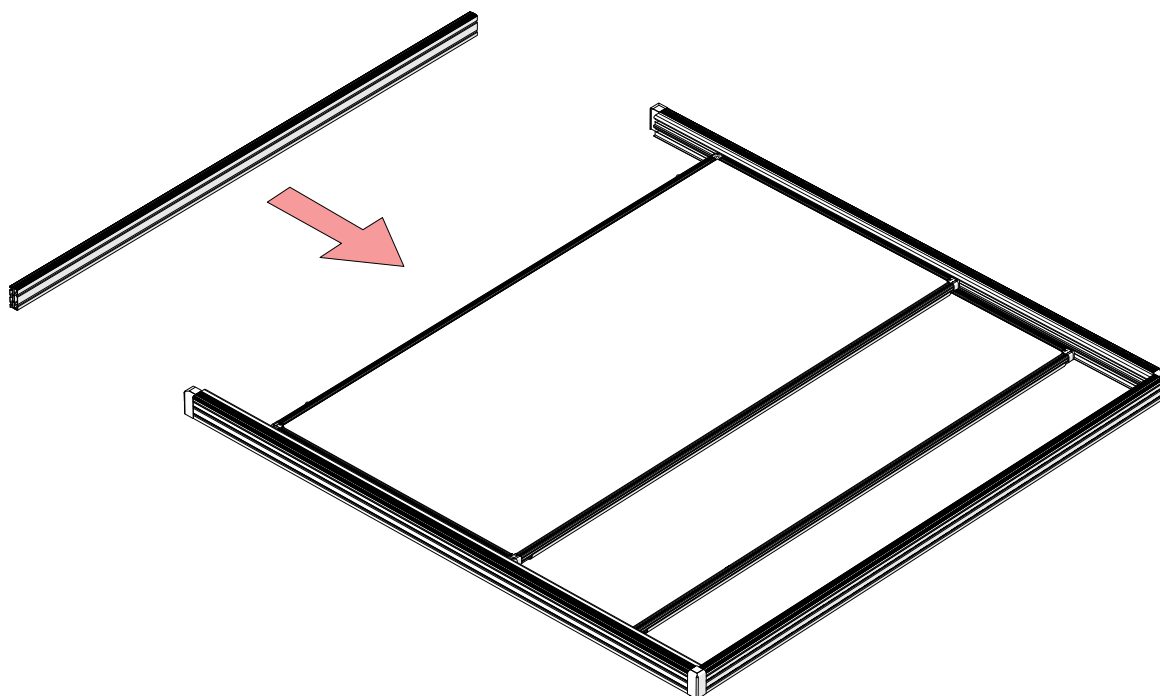

Step 5

Mark two lines on the wall to match the full height of the markerboard assembly. Install "L" brackets into the wall.

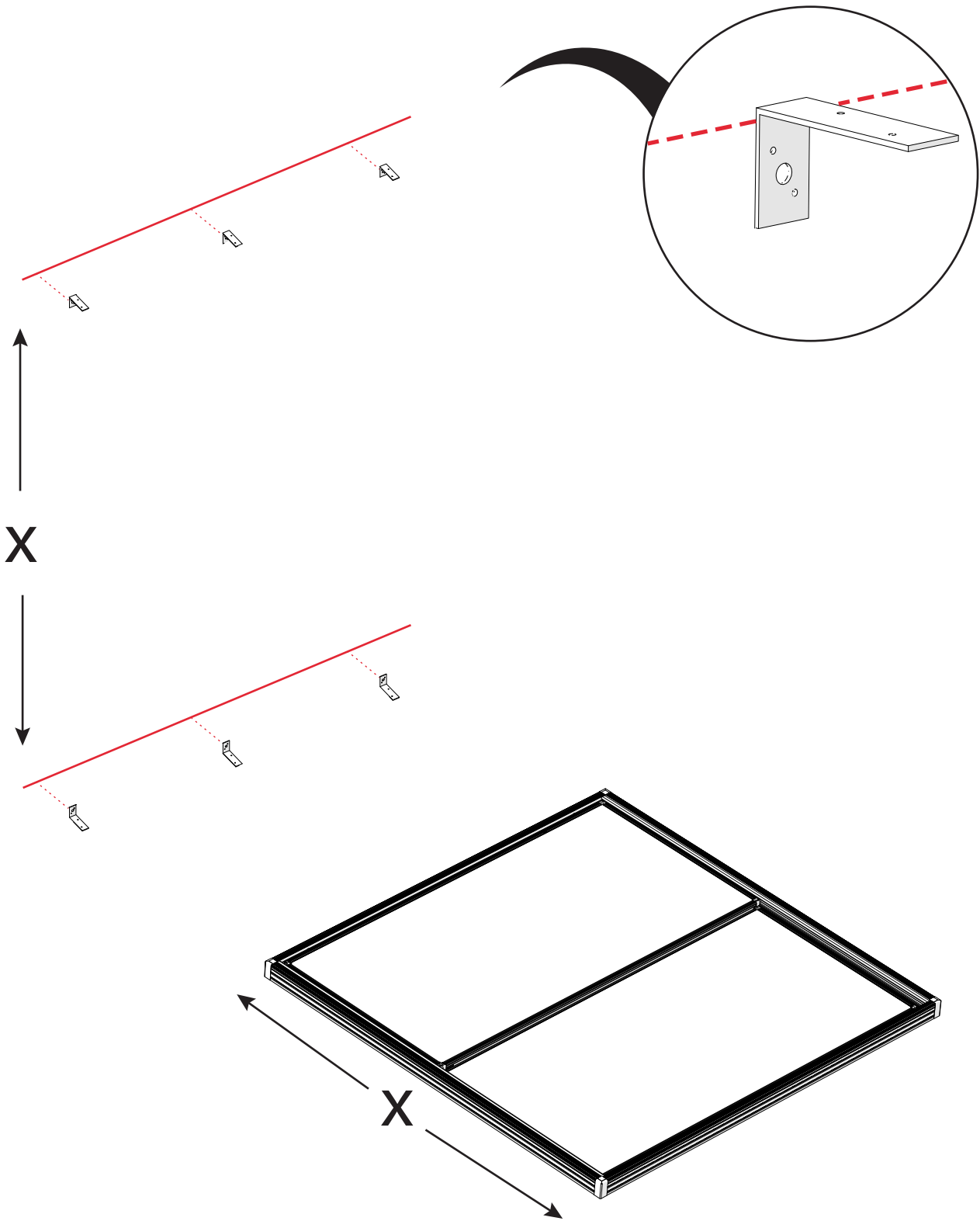

Step 6

Carefully lift the markerboard assembly and set onto the brackets.

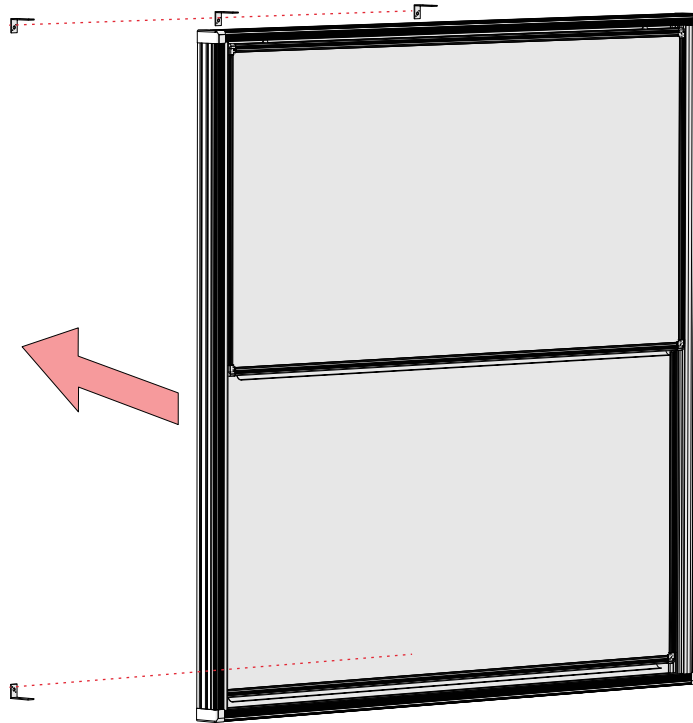

Step 7

Fasten brackets to the frame to complete installation.

